

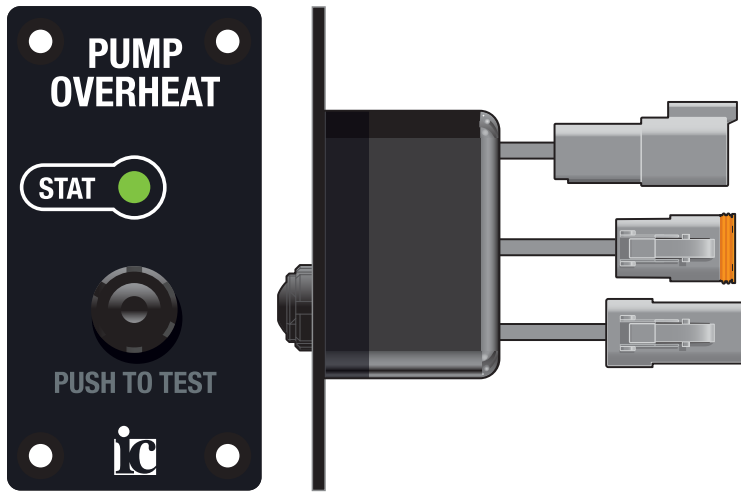

3050803 Pump Overheat System



PUMP OVERHEAT PROTECTION DELIVERED IN A SMART DESIGN

The Innovative Controls Inc. 3050803 Pump Overheat System monitors pump water temperature and at 140°F(60°C) or above can automatically activate an audible alarm and/or a thermal relief valve option that releases water from the pump to the ground or back to the water tank. The optional thermal relief valve automatically closes when the water temperature cools. A status LED tells the operator when the system is dormant (under temp) or active (over temp), and the system can be tested at any time by pressing a Push to Test button.

A wide range of temperature sensor options are available. Custom mounting plates for sensors and relief valve are available upon request.

FEATURES

- Protects Pump from Damage
- Resets Automatically : Auto Dump / Auto Close
- Rated for 600 PSIG use
- Sealed Deutsch Connectors
- -40C to +85C (-40F to +185F) AEC-Q100 Grade 3 Operating Temperature
- Potted Module for Dust and Water Ingress Protection

DIMENSIONS

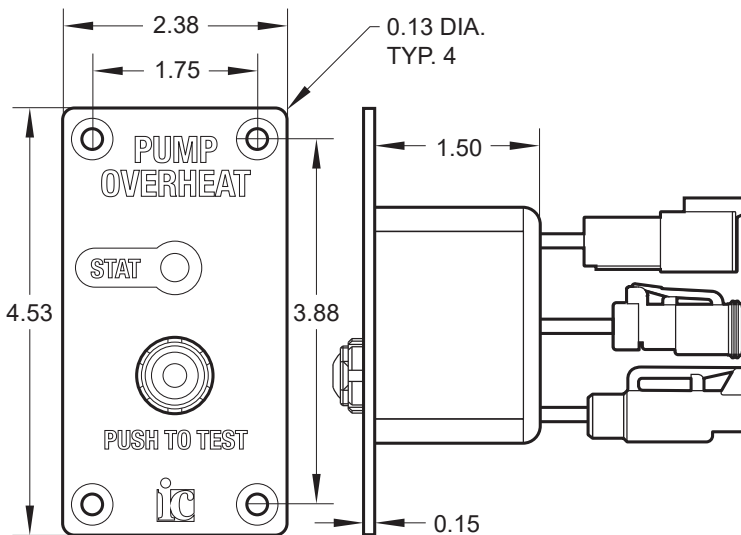

PART NUMBERS

Description	IC Part Number
Alarm Panel / Controller	3050803-01
Vishay Sensor NTCALUG01A103F : Ring Lug	3050814-01
Littlefuse Sensor USP10997 : 1/8"- 27 NPT	3050814-02
Littlefuse Sensor USP10978 : 1/4" NPT	3050814-03
Littlefuse Sensor USP12840 : 10-32 Thread	3050814-04
Littlefuse Sensor USP7766 : Pipe Clamp	3050814-05
EI Sensor Technologies Sensor ETP10072	3050814-06
EI Sensor Technologies Generic ETP10073	3050814-07
EI Sensor Technologies Generic ETP10074	3050814-08
EI Sensor Technologies Generic ETP10130	3050814-09
EI Sensor Technologies Generic ETP10133	3050814-10
EI Sensor Technologies Generic ETP10135	3050814-11
Sensor Extension Cable - XX FT.	3050812-XX
AGB Industries Solenoid Valve P03503814F1D-DH	3050815
Panel Mount Audible Alarm	3050816
Alarm Output Extension Cable - XX FT.	3050813-XX

Alarm Panel / Controller

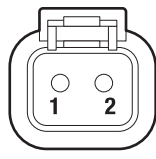
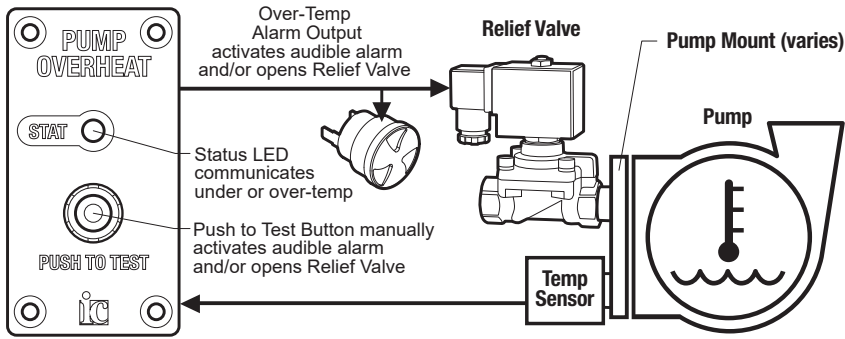
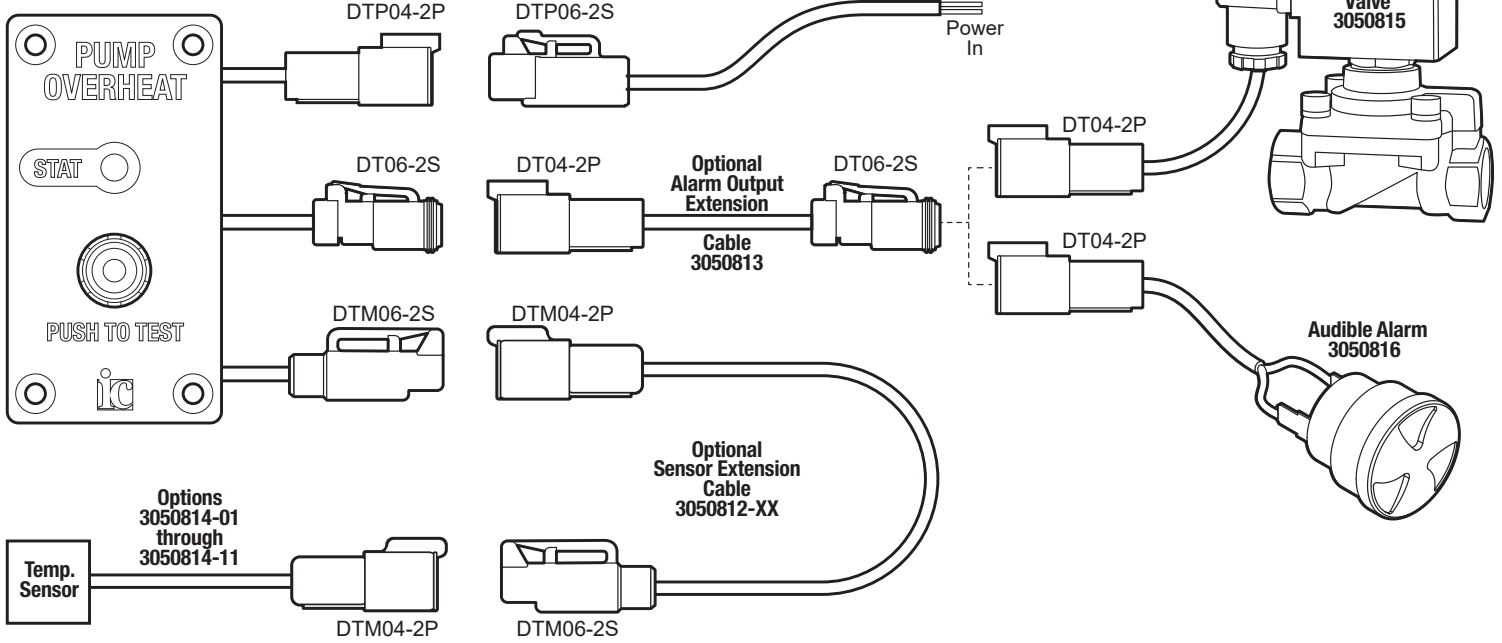

Controller Power In

Deutsch DTP04-2P Connector	
Terminal	Description
1	+12VDC (Battery) Power
2	Ground

Mating connector is Deutsch DTP06-2S with WP-2S wedgelock and 0462-203-12141 or 1062-12-0166 sockets

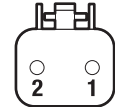

From Controller to Audible Alarm and/or Solenoid Valve

Deutsch DT06-2S Connector	
Terminal	Description
1	Alarm Output (+12VDC) when active
2	Ground

Mating connector is Deutsch DT04-2P with W2P wedgelock and 0460-202-16141 or 1060-16-0122 pins

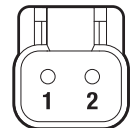

From Controller to Temperature Sensor

Deutsch DTM06-2S Connector	
Terminal	Description
1	Temperature Signal
2	Ground

Mating connector is Deutsch DTM04-2P with W2P wedgelock and 0460-202-16141 or 1060-16-0122 pins

TECHNICAL SPECIFICATIONS

Operating Voltage	7 to 32VDC
Current Consumption with alarm output deenergized at 13.8 VDC	20mA
Current Consumption with alarm output energized at 13.8 VDC	20 mA plus alarm output circuit load
Operating Temperature Range	-40°C to +85°C (-40°F to +185°F)
Storage Temperature Range	-40°C to +85°C (-40°F to +185°F)
Ingress Protection	IP67
Electrical Protection	Reverse voltage polarity protection on all connections Alarm output is protected from reverse polarity, over-current, and voltage transients Power input is protected from reverse polarity, over-current, over-voltage, and voltage transients
Output Current Max	7A max @ 20°C
Controller Dimensions	2.38" wide x 4.53" high x 1.65" deep
Weight	6.7 oz

